



Descrizione del prodotto:

Le lenti di scansione telecentrica Carmanhaas sono una configurazione speciale in cui la disposizione delle ottiche è progettata per focalizzare il raggio in modo che sia sempre perpendicolare al campo piatto. Ciò è particolarmente importante per la perforazione delle applicazioni come la perforazione del foro con circuiti stampati, assicurando che i fori praticati siano perpendicolari alla superficie anche fuori dal centro del campo di scansione. Le applicazioni di saldatura e strutturazione possono anche beneficiare dell'uso di un obiettivo telecentrico, poiché il punto rimane rotondo, anche lungo i bordi del campo.



Le lenti di scansione telecentrica sono sempre progetti multi-elemento e sono forniti in un alloggiamento. Almeno un elemento di lente sarà più grande delle dimensioni del campo da scansione. In pratica, ciò significa che per ragioni di fabbricazione e costi che sono possibili solo piccole dimensioni del campo, a loro volta che implicano brevi lunghezze focali. Ogni applicazione specifica richiede soluzioni personalizzate per questi tipi di lenti. Contattaci con le tue specifiche per un design preliminare e noi [Cina produttore di lenti telecentriche](#) ci citerà.

Caratteristiche:

- (1) Elevata precisione, piccolo errore di assemblaggio: $< 0.05\text{mm}$
- (2) Alta trasmissione: $> / = 99,8\%$
- (3) Soglia di danno elevata: $10\text{GW} / \text{cm}^2$

Carmanhaas Vantaggi:

- (1) fatto per i requisiti personalizzati.
- (2) Design in-house avanzato, basato su anni di innovazione nel campo
- (3) raggio perpendicolare per applicazioni critiche

Clicca per vedere di più: [Prezzo delle lenti telecentriche Cina](#)

1030-1090nm Fiber Laser



532nm Green Laser



355nm UV Laser



Parametri tecnici:

532nm Telecentric F-Theta Scan Lenses

Part Description	FL(mm)	Scan Field (mm)	Max Entrance Pupil (mm)	Working Distance (mm)	Mounting Thread
TSL-532-50-100-(15CA)	100	50x50	15	123.6	M85x1
TSL-532-165-277-(15CA)	277	165x165	15	355.8	M102x1

Optical System Layout

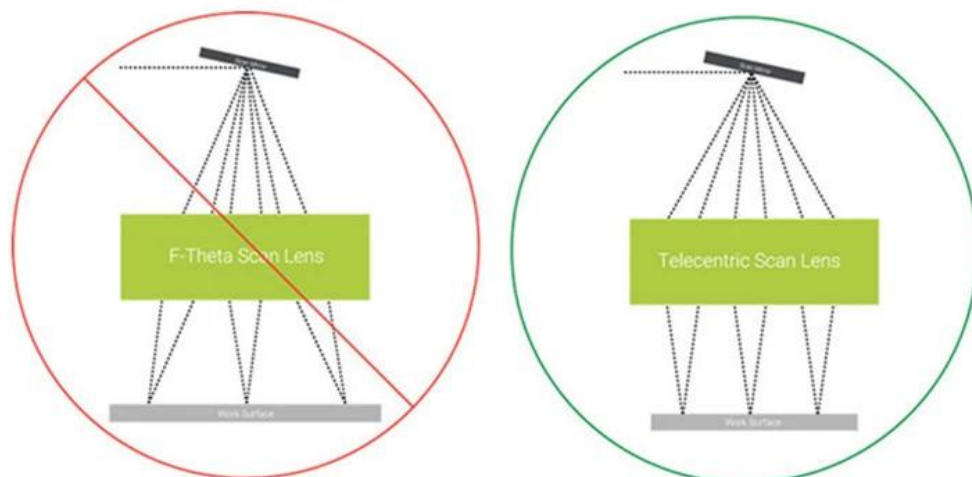
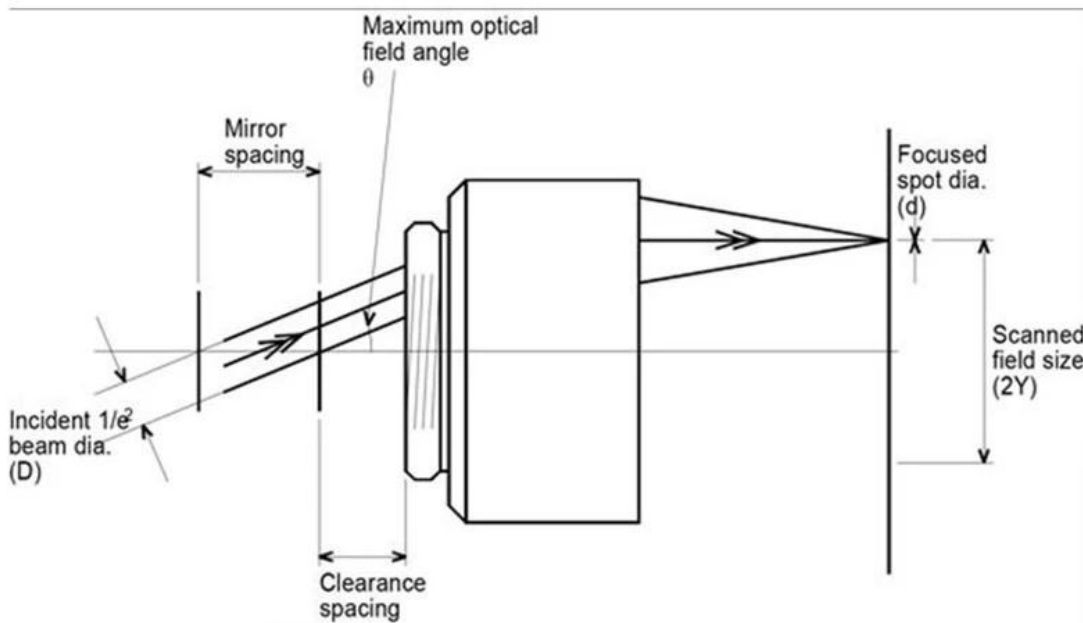
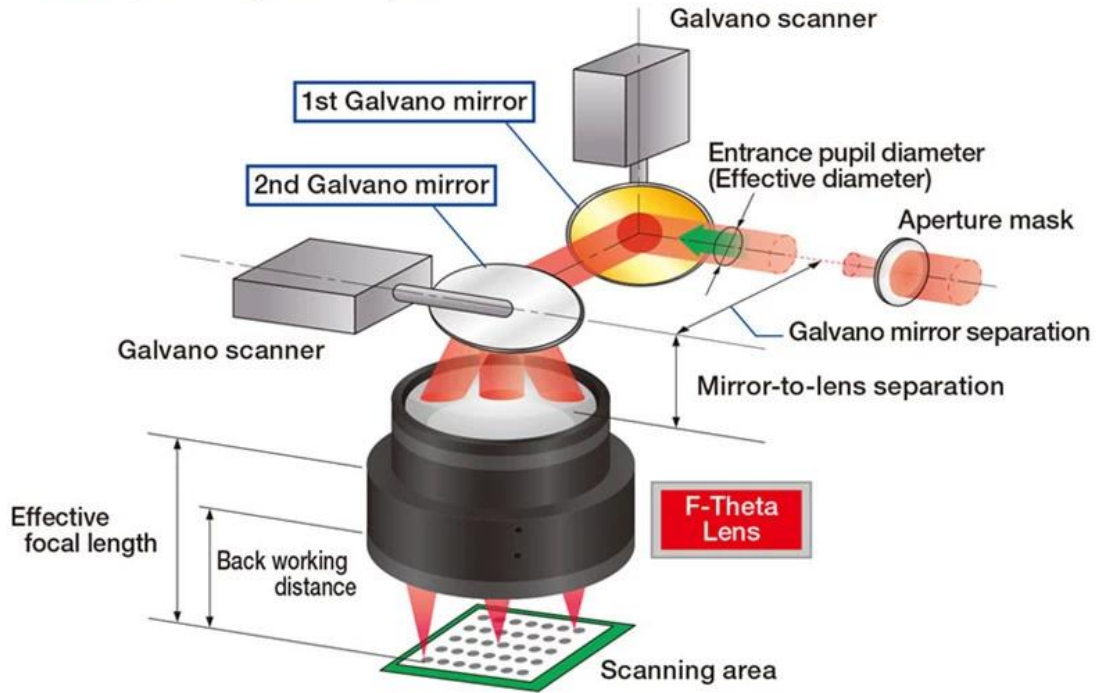
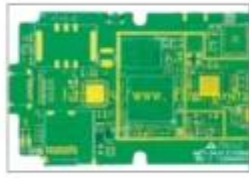
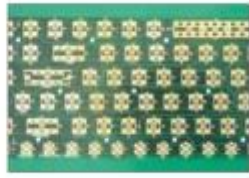
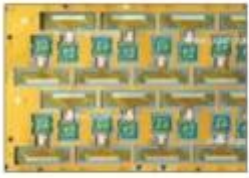

Figure 2: Non-telecentric vs. telecentric f-theta lenses.



Factory







重要仪器,
非专业人士勿动。

OptiCentric 300

TRIOPTICS





PerkinElmer Lambda 950---Testing Transmission and Reflectivity







C E R T I F I C A T E

ATTESTATION CERTIFICATE OF MACHINERY AND LOW VOLTAGE DIRECTIVES

Technical file of the company mentioned below has been observed and audit has been completed successfully. 2006/42/EC Machinery Directive and 2014/ 35/EU Low Voltage Directive have been taken as references for these processes

Company Name : **Camman HAAS Laser Technology (Suzhou) Co., Ltd.**

Company Address : No 155, West Road Suhong, Suzhou Industrial Park, Suzhou City, Jiangsu , P.R.China

Related Directives and Annex : **Low Voltage Directive 2014/35/EU
Machinery Directive 2006/42/EC**

Related Standards : **EN ISO 12100:2010; EN 60204-1:2006+A1:2009-AC:2010**

Product Name : **Laser Marking Machine**

Report No and Date : SD-90049717:09.08.2018

Product Brand/Model/Type : LMCH-3W,LMCH-5W,LMCH-10W,LMCH-15W,LMCH-20W,LMCH-25W,
LMCH-30W,LMCH-50W,LMCH-60W,LMCH-70W,LMCH-100W,
LMCH-120W,LMCH-150W,LMCH-200W,LMCH-300W,LMCH-500W

Certificate Number : **M.2018.201.N6073**

Initial Assessment Date : 10.08.2018

Registration Date : 13.08.2018

Reissue Date/No :

Expiry Date : **12.08.2023**

Signature
UDEM International Certification
Auditing Training Centre Industry
and Trade Inc. Co.



The validity of the certificate can be checked through www.udem.com.tr. The CE mark shown on the right can only be used under the responsibility of the manufacturer with the completion of EC Declaration of Conformity for all the relevant Directives. This certificate remains the property of UDEM International Certification Auditing Training Centre Industry and Trade Inc. Co. to whom it must be returned upon request. The above named firm must keep a copy of this certificate for 15 years from the registration of certificate. This certificate only covers the product(s) stated above and UDEM must be notified in case of any changes on the product(s).
Address: Mithakere Mahalleli 2073 Sokak (Eski 93 Sokak) No:10 Çankaya - Ankara - TÜRKİYE
Phone: +90 0312 443 03 90 Fax: +90 0312 443 03 76
E-mail: info@udemtd.com.tr www.udem.com.tr



Certificate of Approval

Certificate No.: 10119Q12565ROM

Awarded to

**Carman Haas Laser Technology(SuZhou)
Co., Ltd.**

Organization Code Certificate No. / Unified Social Credit Code:91320594MA1MF4EP56
Add.:No.155, West Road Suhong, Suzhou Industrial Park, Suzhou City, Jiangsu Province, P.R. China. 215000

Beijing ZhongLianTianRun Certification Center (ZLTR) certify that the
Quality Management System of the above organization has been assessed and found to be
in accordance with the requirements of the standard:
GB/T19001-2016 / ISO9001:2015

SCOPE OF CERTIFICATION/REGISTRATION
The Research and Development and Production of Optics Lenses (Except the limits of
national laws and regulations.)

This certificate is made valid when used with certification scopes and the requirements of applicable
laws and regulations. These requirements include, but are not limited to, administrative permits,
scopes of qualifications, and CCC requirements.

Subject to operation conditions in requirements conformity with Quality Management System,

This Certificate is valid for a period of three years only,
Date from: **Mar 13th,2019 To: Mar 12th,2022**

The effectiveness of this Certificate shall be Validated by periodic surveillance audit
of ZLTR for maintenance.

Information of this certificate can be found on the official website of Beijing Zhonglian Tianrun
Certification center (<http://www.zltr.com.cn>)



Beijing Zhongliantianrun Certification Center

Room2003, 22nd Floor, 21st Unit, Block 1, No.4 Yard, Qiyang Road, Chaoyang District, Beijing, P.R. China 100102

Information of this certificate can be found on the official website of Certification and Accreditation Administration of the People's Republic of China (<http://www.cnca.gov.cn>)

ISO 9001

ISO 9001



Packing List

Packaging & Shipping

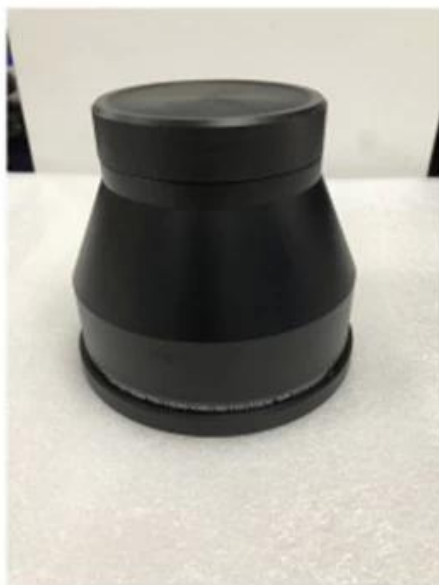

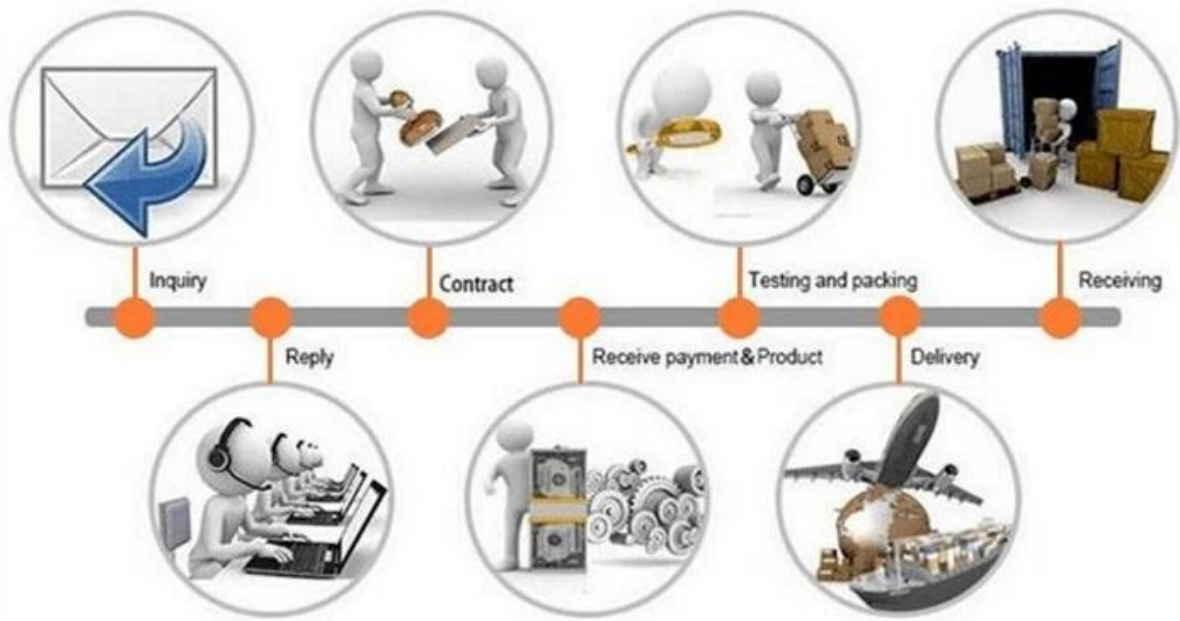

Politica di ritorno:

I rendimenti dovrebbero essere richiesti:

Passaggio 1) Contattaci con questa email del sito web.
Passaggio 2) Fornisci più dettagli possibili sul problema che stai avendo.
Passaggio 3) Autorizzazione per restituire l'articolo verrà emesso.
Passaggio 4) Restituire la voce per la sostituzione o il rimborso concordato.

La logistica:

(1) Per la consegna dell'ottica laser, può essere opzionale con DHL, UPS, FedEx, TNT, EMS, ETS

(2) per Laser macchina ordine Consegna, Can. essere opzionale insieme a Termini di Ex lavoro Fob, cnf, cif Di Aria odi Mare basato Sul acquirente spedizionier nostro.



FAQ

Q1. Un produttore?

A1: Sì, siamo produttori professionali ed esperti con i nostri stampi e linee di produzione.

Q2. Come sulla qualità dei prodotti?

A2: I nostri tecnici e i nostri team di controllo qualità testano i prodotti uno per uno utilizzando la linea di invecchiamento, dispositivi professionali e strumenti per garantire la qualità per tutti i prodotti.

Q3. Come sul prezzo?

A3: Siamo un produttore e offriamo sempre ai nostri clienti i prezzi più competitivi.

Q4. Come effettuare un ordine?

A4: contatto con il servizio online, o inviato un'e-mail direttamente a noi, ti risponderemo con il prezzo del prodotto, le specifiche, l'imballaggio ecc. Presto. Grazie.

Q5. Bay I Invio materiale per testare le prestazioni di marcatura?

A5: Sì! Siete invitati a inviare materiale per testare la nostra qualità e servizio di qualità superiore.

Q6. Can Io visito la tua fabbrica?

A6: Sì, benvenuto a visitare la nostra fabbrica al tuo tempo conveniente.

Q7. Come posso fare ordini OEM o ODM?

A7: abbiamo diverse elaborazioni di stampa per diversi OEM / ODM ORDers. Vi preghiamo di contattarci con il servizio online o invia direttamente email direttamente.

Q8. Come dovrei pagare per i miei ordini?

A8: è possibile pagare con T / T sarebbe disponibile per Bank qualificato e MOQ richiesto per ogni ordine.