

□□ □□ :

[□□□ □□ □□ □□ □□ □□](#) □□ □□ □□ □ □□□ □□□ □□ □□

a :

28mm (OEM Precitec P0571-1051-001-1051-001)

□□ : 28 / 24.5mm □□ : 12mm

□□ B :

28mm (OEM Precitec P0571-260-00001)

□□ : 28 / 24.5mm □□ : 12mm

□□ C :

32mm (OEM raytools bt240 / bm109)

□□ : 32 / 28.5mm □□ : 12mm

□□ □□:

(1) □□ □□□, □□□□ □□, □ □□

(2) □□□ □□ □□, □□ □□□, □□ □□

(3) □□□□ □□, □ □□



Features

Complete specifications, Spot sale.
 Long life time, Not easy to crack, Not easily stained with ash.
 Low Loss Anti-reflectanc, High Efficiency.
 CNC milling and turning, drilling, grinding, tapping, high accuracy and small error.
 100% inspection before shipment, quality assurance.

Product Details

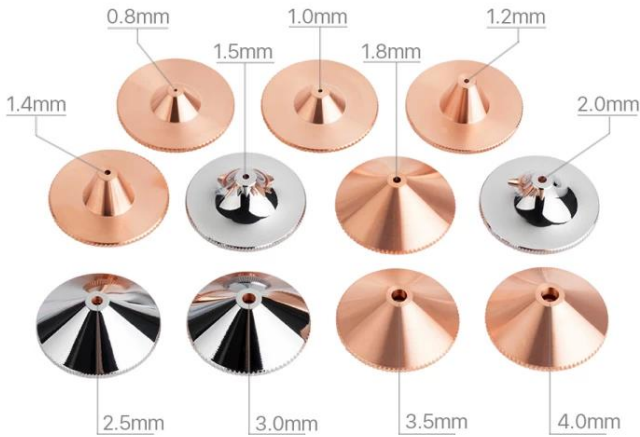

Single Nozzle
 Diameter: 28mm
 Height : 15mm
 Thread : M11

Double Nozzle
 Diameter : 32mm
 Height : 15mm
 Thread : M14





PRODUCT SPECIFICATIONS

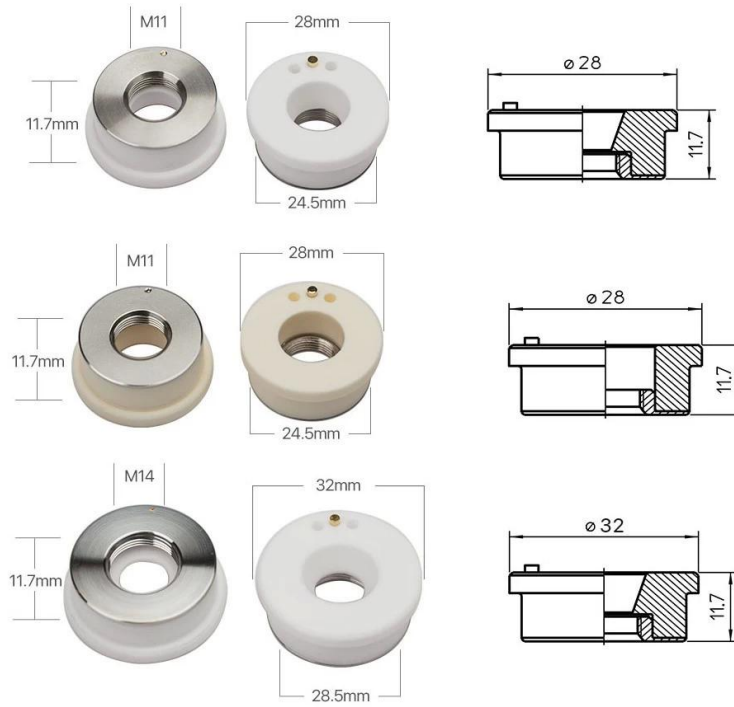

PACKAGING



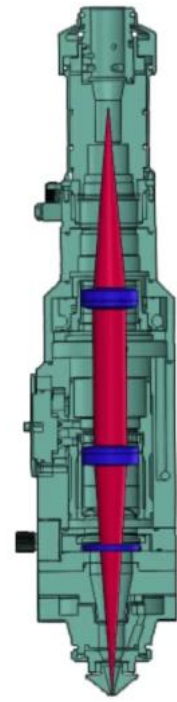
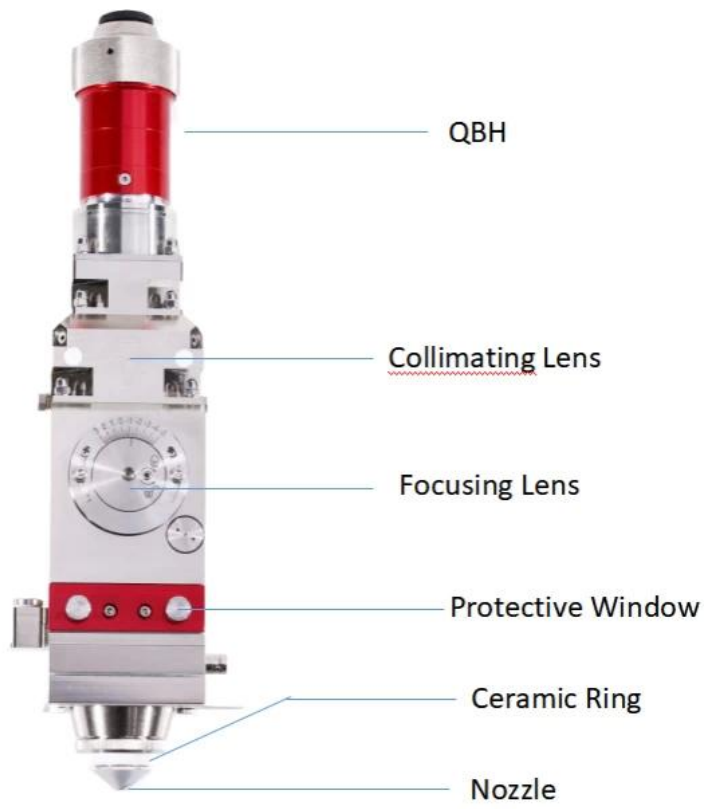

光纤切割头光路示意图
Figure of Fiber Cutting Head





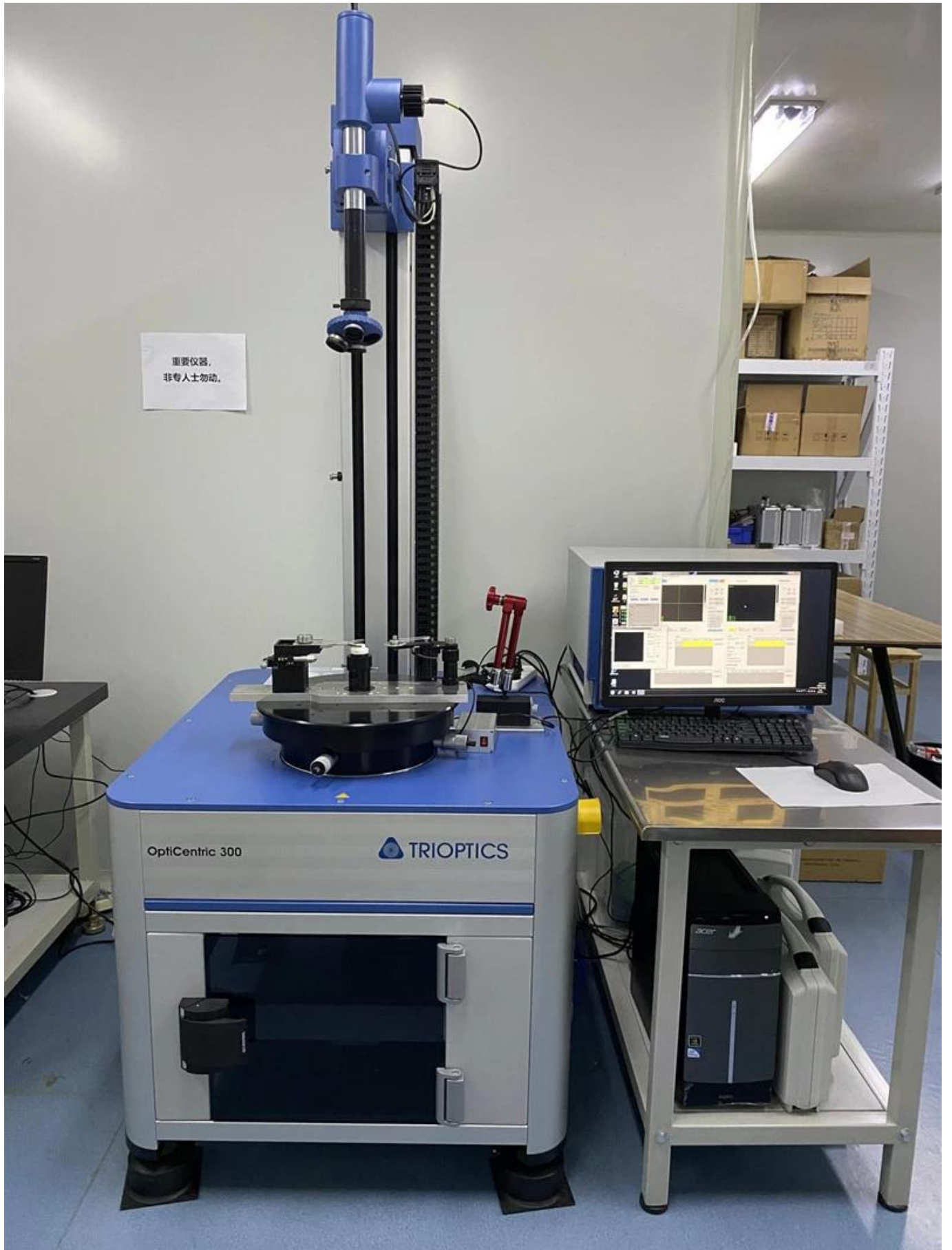

重要仪器,
非专业人士勿动。

OptiCentric 300

TRIOPTICS



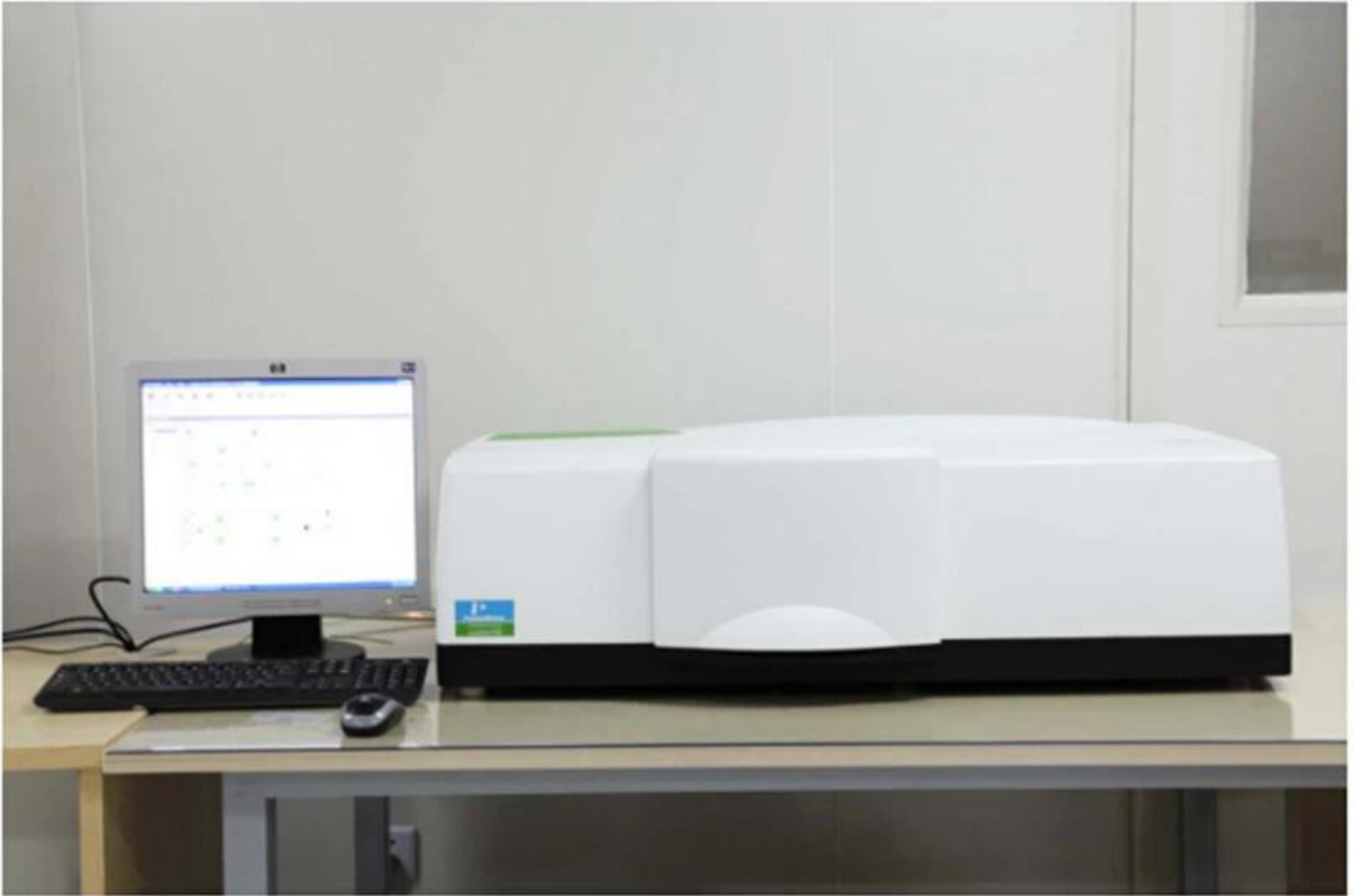

PerkinElmer Lambda 950---Testing Transmission and Reflectivity



□□□ □ □□



CERTIFICATE

ATTESTATION CERTIFICATE OF MACHINERY AND LOW VOLTAGE DIRECTIVES

Technical file of the company mentioned below has been observed and audit has been completed successfully. 2006/42/EC Machinery Directive and 2014/35/EU Low Voltage Directive have been taken as references for these processes

Company Name : **Camnan HAAS Laser Technology (Suzhou) Co., Ltd.**

Company Address : No 155, West Road Suhong, Suzhou Industrial Park, Suzhou City, Jiangsu , P.R.China

Related Directives and Annex : **Low Voltage Directive 2014/35/EU
Machinery Directive 2006/42/EC**

Related Standards : **EN ISO 12100:2010; EN 60204-1:2006+A1:2009+AC:2010**

Product Name : **Laser Marking Machine**

Report No and Date : SD-90049717:09.08.2018

Product Brand/Model/Type : LMCH-3W,LMCH-5W,LMCH-10W,LMCH-15W,LMCH-20W,LMCH-25W,
LMCH-30W,LMCH-50W,LMCH-60W,LMCH-70W,LMCH-100W,
LMCH-120W,LMCH-150W,LMCH-200W,LMCH-300W,LMCH-500W

Certificate Number : **M.2018.201.N6073**

Initial Assessment Date : 10.08.2018

Registration Date : 13.08.2018

Reissue Date/No :

Expiry Date : **12.08.2023**

Signature
UDEM International Certification
Auditing Training Centre Industry
and Trade Inc. Co.



The validity of the certificate can be checked through www.udem.com.tr. The CE mark shown on the right can only be used under the responsibility of the manufacturer with the completion of EC Declaration of Conformity for all the relevant Directives. This certificate remains the property of UDEM International Certification Auditing Training Centre Industry and Trade Inc. Co. to whom it must be returned upon request. The above named firm must keep a copy of this certificate for 15 years from the registration of certificate. This certificate only covers the product(s) stated above and UDEM must be notified in case of any changes on the product(s)
Address: Mulkikent Mahallesi 2073 Sokak (Eski 93 Sokak) No:10 Çankaya - Ankara - TÜRKİYE
Phone: +90 0312 443 03 90 Fax: +90 0312 443 03 70
E-mail: info@udemtd.com.tr www.udem.com.tr



Certificate of Approval

Certificate No.: 10119Q12565ROM

Awarded to

**Carman Haas Laser Technology(SuZhou)
Co., Ltd.**

Organization Code Certificate No. / Unified Social Credit Code:91320594MA1MF4EP56
Add.:No.155, West Road Suhong, Suzhou Industrial Park, Suzhou City, Jiangsu Province, P.R. China. 215000

Beijing ZhongLian TianRun Certification Center (ZLTR) certify that the
Quality Management System of the above organization has been assessed and found to be
in accordance with the requirements of the standard:
GB/T19001-2016 / ISO9001:2015

SCOPE OF CERTIFICATION/REGISTRATION

The Research and Development and Production of Optics Lenses (Except the limits of national laws and regulations.)

This certificate is made valid when used with certification scopes and the requirements of applicable laws and regulations. These requirements include, but are not limited to, administrative permits, scopes of qualifications, and CCC requirements.

Subject to operation conditions in requirements conformity with Quality Management System,

This Certificate is valid for a period of three years only,
Date from: Mar 13th,2019 To: Mar 12th,2022

The effectiveness of this Certificate shall be Validated by periodic surveillance audit of ZLTR for maintenance.

Information of this certificate can be found on the official website of Beijing Zhonglian Tianrun Certification center (<http://www.zltr.com.cn>)



Beijing Zhongliantianrun Certification Center

Room2603, 22nd Floor, 2nd Unit, Block 1, No.4 Yard, Qiyang Road, Chaoyang District, Beijing, P.R. China 100102

Information of this certificate can be found on the official website of Certification and Accreditation Administration of the People's Republic of China (<http://www.cnca.gov.cn>)

ISO 9001

ISO 9001



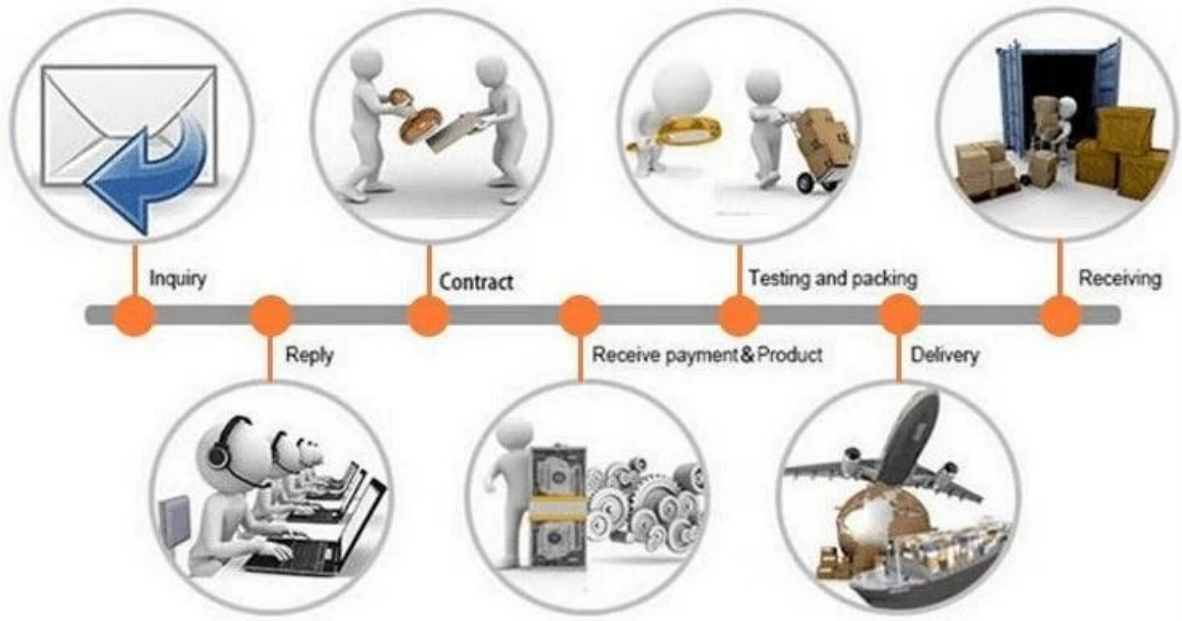

□□ □□ :

□□□□□□□□.

